

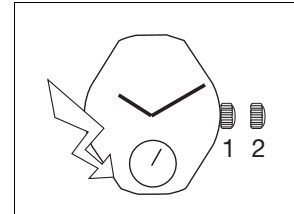

6 3/4" x 8" ETA 902.501

CT 902501 FDE 486679 05 05.11.2013

6 3/4" x 8" Ø 15,30 x 17,80 mm



Hauteur sur mouvement	Höhe auf Werk	Movement height	2,90 mm
Hauteur sur pile	Höhe auf Batterie	Height on battery	2,90 mm
Nombre de rubis	Anzahl Rubine	Number of jewels	4
Fréquence	Frequenz	Frequency	32'768 Hz

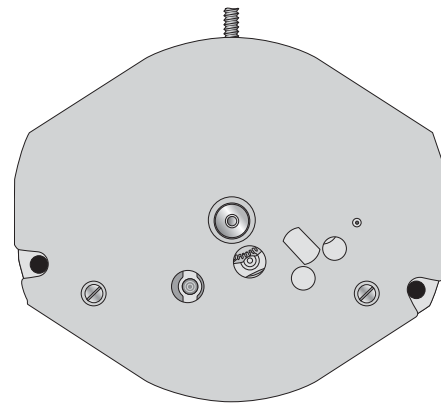
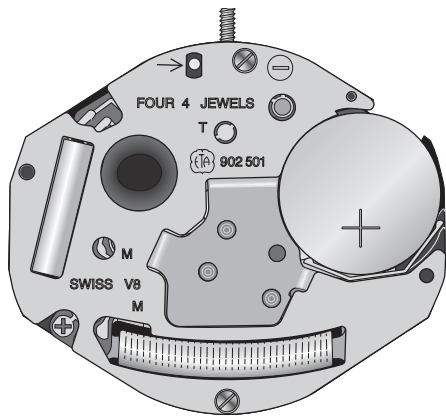

Les travaux de réparation et de révision ne doivent être effectués que par du personnel dûment formé.
Reparatur- und Revisionsarbeiten dürfen nur von ausgebildetem Fachpersonal ausgeführt werden.
The repair and reconditioning work must only be performed by properly trained personnel.



Informations générales



Avant de démarrer les travaux, veuillez svp étudier attentivement cette "Communication technique".



La protection des yeux est obligatoire pour toutes les interventions / tous les travaux sur le mouvement!



ETA SA décline toute responsabilité en cas de dommages du non respect de cette "Communication technique".

Exigences en matière de protection de l'environnement



Les dispositions légales en matière de traitement et d'élimination des déchets doivent être respectées lors de toutes les interventions / tous les travaux sur les mouvement!

En particulier, les produits de graissage et de nettoyage néfastes pour l'environnement doivent être éliminés selon les règles!



Les **substances de nature à polluer l'eau** doivent être entreposées, transportées, récupérées et éliminées dans des récipients adéquats.

Elles ne doivent en aucun cas polluer le sol ou être évacuées dans les réseaux de canalisation!

Explication des symboles



Attention! Risque de dégât matériel!

Ci-après quelques instructions à suivre obligatoirement pour éviter tout dégât matériel!

Allgemeine Informationen



Diese "Technische Mitteilung" ist **vor** dem Beginn der Arbeiten genauestens zu studieren.



Für sämtliche Arbeiten am und mit dem Uhrwerk ist ein Augenschutz obligatorisch!



Für Schäden, welche durch Nichtbeachtung dieser "Technischen Mitteilung" entstehen, haftet die ETA SA nicht.

Umweltschutz-Vorschriften



Bei allen Arbeiten am und mit dem Uhrwerk sind die gesetzlichen Vorschriften zur ordnungsgemässen Verwertung und Beseitigung der Abfälle einzuhalten!

Insbesondere sind umweltgefährdende Schmier- und Reinigungsmittel ordnungsgemäss zu entsorgen!



Wassergefährdende Stoffe müssen in geeigneten Behältern aufbewahrt, transportiert, aufgefangen und entsorgt werden.

Diese dürfen nicht den Boden belasten oder in die Kanalisation gelangen!

Symbolerklärung



Achtung! Gefahr von Sachschäden!

Hier folgen wichtige Hinweise, die zur Vermeidung von Sachschäden unbedingt beachtet werden müssen!

General information



Before starting work, please study this "Technical communication" carefully.



Eye protection is obligatory for all operations / work on the movement!



ETA SA disclaims any liability in case of damage arising from failure to observe this "Technical communication".

Environmental protection requirements



The legal provisions relating to waste handling and disposal must be observed in all operations / work on the movement!

In particular, lubricating and cleaning products harmful to the environment must be disposed of in accordance with the rules!



Substances prone to cause water pollution must be stored, transported, collected and disposed of in appropriate vessels.

Under no circumstances must they pollute the soil or be poured into sewage systems!

Explanation of symbols



Caution! Risk of material damage!

Below are some obligatory instructions for preventing any material damage!

Liste des fournitures - Bestandteilliste - List of components

Pos	No Nr No	No Nr CS No	Numéro d'article Artikelnummer Article number		Liste des fournitures	Bestandteilliste	List of components
-	100	10.020.07	Var		Platine montée, empierrée	Werkplatte mit Steinen, montiert	Main plate assembled and jewelled
-	110	10.048.07	Var		Pont de rouage, empierré	Räderwerkbrücke, mit Steinen	Train wheel bridge, jewelled
-	129	10.050.00	Var		Pont de roue supplémentaire de rouage	Brücke für Zusatzräder im Räderwerk	Additional train wheel bridge
-	203	30.012.00	-		Roue intermédiaire	Zwischenrad	Intermediate wheel
-	210	30.025.00	-		Roue moyenne	Kleinbodenrad	Third wheel
-	215	30.029.00	-		Roue intermédiaire de seconde	Zwischen-Sekundenrad	Intermediate second wheel
-	222	30.030.00	Var		Roue de seconde supplémentaire	Zusatz-Sekundenrad	Additional second wheel
-	227/3	30.027.18	-		Roue de seconde, sans seconde au centre	Sekundenrad, ohne Zentralsekunde	Second wheel, without sweep second
-	242/1	31.083.18	Var		Chaussée avec roue entraîneuse sans seconde au centre	Minutenrohr mit Mithnehmer, ohne Zentralsekunde	Cannon pinion with driver, without sweep second
-	250/1	31.046.06	Var		Roue des heures avec ressort-friction, montée	Stundenrad, mit Friktionsfeder, montiert	Hour wheel, with friction spring, assembled
-	259	81.171.00	-		Rondelle de roue de chaussée	Unterlegscheibe für Minutenrohr	Cannon pinion washer
-	260	31.041.00	-		Roue de minuterie	Wechselrad	Minute wheel
-	405	51.020.00	Var		Tige de mise à l'heure	Stellwelle	Handsetting stem
-	407	31.121.00	-		Pignon coulant	Kupplungstrieb	Sliding pinion
-	435	51.050.00	-		Bascule de pignon coulant	Kupplungstriebhebel	Yoke
-	443/1	51.080.06	-		Tirette, montée	Winkelhebel, montiert	Setting lever, assembled
-	462	10.062.00	-		Pont de rouage de minuterie	Wechselradbrücke	Minute train bridge
-	4000	10.513.00	Var		Module électronique	Elektronik-Baugruppe	Electronic module
-	4021	20.582.00	-		Stator	Stator	Stator
-	4211	20.580.00	Var		Rotor	Rotor	Rotor
-	4255	10.700.00	-		Couvre module électronique	Halteplatte für Elektronik-Baugruppe	Electronic module cover
-	4401	20.761.00	-		Bride +	Bügel +	Bridle +
-	4929	20.570.00	-		Pile 6,80 mm x 2,15 mm	Batterie 6,80 mm x 2,15 mm	Battery 6,80 mm x 2,15 mm
-	9511	36.033.00	-		Roue intermédiaire de transmission	Übertragungs-Zwischenrad	Intermediate transmission wheel
1)	5110	10.048.01	Var	2x	Vis de pont de rouage	Schraube für Räderwerkbrücke	Screw for train wheel bridge
1)	5129	10.050.01	Var	2x	Vis de pont de roue supplémentaire de rouage	Schraube für Brücke für Zusatzräder im Räderwerk	Screw for additional train wheel bridge
-	5462	10.062.01	-	1x	Vis de pont de rouage de minuterie	Schraube für Wechselradbrücke	Screw for minute train bridge
1)	54000	10.513.01	Var	3x	Vis de module électronique	Schraube für Elektronik-Baugruppe	Screw for electronic module
-	54255	10.700.01	-	2x	Vis de couvre-module électronique	Schraube für Deckplatte für Elektronik-Baugruppe	Screw for electronic module cover
					Vis identiques Identische Schrauben Identical screws	1) 5110 5129 54000	
			Var		Variante	Variante	Variant

L'interchangeabilité et les variantes se trouvent sur ETA ONLINE SHOP (EOS) :

www.eta.ch
→ Support Center
→ Support Center Portal













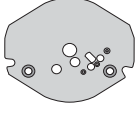











Die Austauschbarkeit und Varianten finden Sie im ETA ONLINE SHOP (EOS):

www.eta.ch
→ Support Center
→ Support Center Portal

Interchangeability and variants can be found on the ETA ONLINE SHOP (EOS):

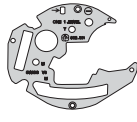
www.eta.ch
→ Support Center
→ Support Center Portal

Fournitures - Bestandteile - Materials

								
100 Var	110 Var	129 Var	203	210	215	222 Var	227/3	5110 Var 5129 Var 54000 Var
								
242/1 Var	250/1 Var	259	260	405 Var	407	435	443/1	462
								
4000 Var	4021	4211 Var	4255	4401	4929	9511	54255	

Ordre d'assemblage - Montager Reihenfolge - Order of assembly:
 Mécanisme de mise à l'heure - Zeigerwerkmechanismus - Handsetting mechanism

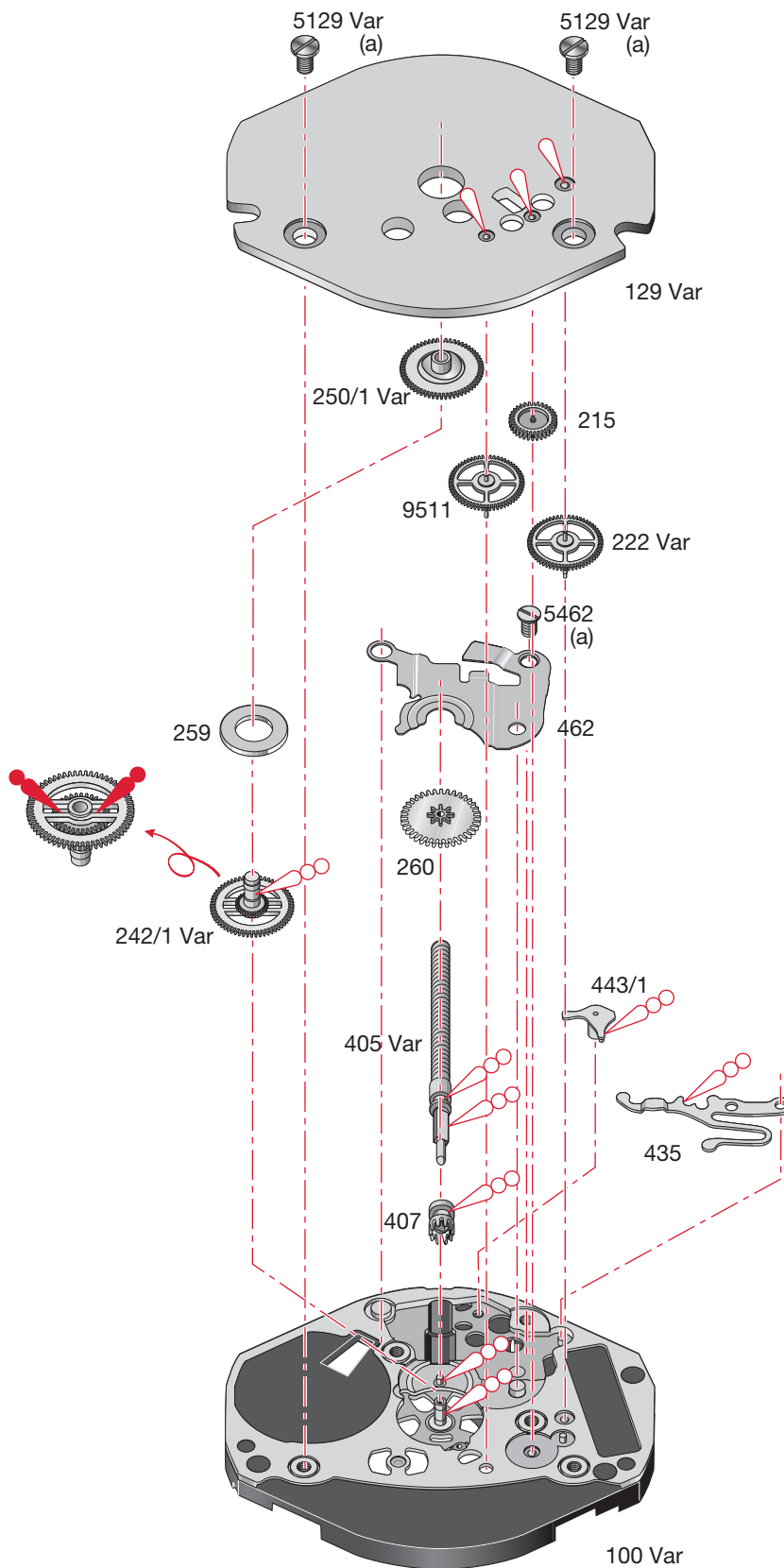

Montage du mécanisme de mise à l'heure

(Liste des fournitures par ordre d'assemblage)

Zusammenstellen des Zeigerwerkmechanismus

(Bestandteilliste in Montagereihenfolge)

Assembling of the handsetting mechanism

(Parts listed in order of assembly)

100 Var	259	215
407	260	222 Var
405 Var	462	129 Var
443/1	5462 (1x)	5129 Var (2x)
435	250/1 Var	
242/1 Var	9511	

Lubrification - Schmierung - Lubrication

 Huile fine
Dünnflüssiges Öl **Moebius 9014**
Fine oil

 Huile épaisse ou graisse **Moebius**
Dickflüssiges Öl oder Fett **HP-1300**
Thick oil or grease ou / oder / or
Moebius D5

 Très faible quantité **Moebius**
Sehr kleine Menge **HP-1300**
Very small quantity ou / oder / or
Moebius D5

 Graisse **Moebius 9501**
Fett ou / oder / or
Grease **Jismaa 124**

M_L Couple minimum pour dévisser**M_L Minimales Drehmoment zum Lösen****M_L Minimum torque for loosening**

(a) 0,7 Ncm

Ordre d'assemblage - Montager Reihenfolge - Order of assembly:
 Mouvement de base et module électronique - Basiswerk und der Elektronik-Baugruppe - Basic movement
 and the electronic module

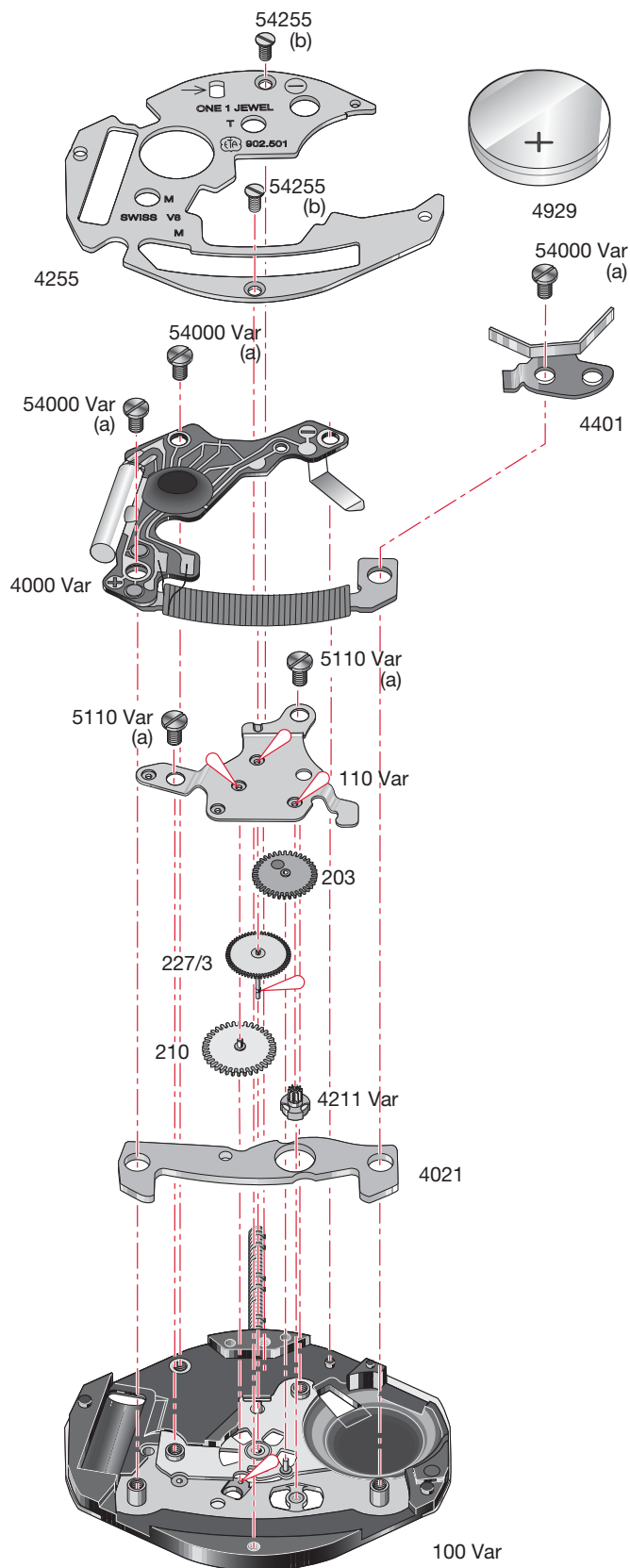

Montage du mouvement de base et du module électronique

(Liste des fournitures par ordre d'assemblage)

Zusammenstellen des Basiswerkes und der Elektronik-Baugruppe

(Bestandteilliste in Montagerihenfolge)

100 Var	203	54000 Var (3x)
4021	110 Var	4255
4211 Var	5110 Var (2x)	54255 (2x)
210	4000 Var	4929
227/3	4401	

Lubrification - Schmierung - Lubrication

 Huile fine
Dünnflüssiges Öl **Moebius 9014**
Fine oil

M_L Couple minimum pour dévisser

M_L Minimales Drehmoment zum Lösen

M_L Minimum torque for loosening

- (a) 0,7 Ncm
- (b) 0,6 Ncm

Contrôles électriques - Elektrische Kontrollen - Electrical Tests

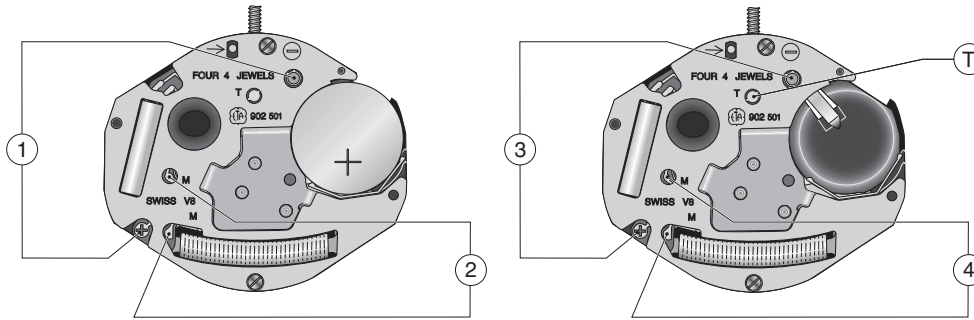

Position Messpunkt Position	Echelle de mesure Einstellung Messgerät Setting of apparatus	Mesure Messung Measurement	Contrôle Kontrolle Test	Remarques Bemerkungen Remarks
1	2 V (Ri > 10 kΩ/V)	1,55 V	Tension de la pile. Spannung der Batterie. Battery voltage.	Mesure avec pile. Messung mit Batterie. Measurement with battery.
2	1 V (Ri > 10 kΩ/V)	L'aiguille du multimètre oscille en sens + et -. Zeiger im Messgerät pulsiert im + und - Sinn. Hand of measuring apparatus oscillates in + and - direction.	Impulsion à la sortie du circuit intégré: Ausgangsimpulse am integrierten Schaltkreis: Impulses at output of integrated circuit: 1/1 s	Mesure avec une pile contrôlée. Messung mit kontrollierter Batterie. Measurement with controlled battery.
3	2 V	≤ 1,30 V Pour accélérer le moteur, connecter le point T à la piste -. Zum Beschleunigen des Motors Punkt T mit Leiterbahn - verbinden. For accelerating the motor, connect point T to - printer circuit conductor.	Limite inférieure de la tension de fonctionnement. Untere Funktionsspannungsgrenze. Lower working-voltage limit.	Mesure sans pile, alimentation extérieure variable, en descendant de 1,55 V à l'arrêt du mouvement. Messung ohne Batterie, mit variabler Speisung von aussen, Spannung von 1,55 V bis zum Stillstand des Werkes reduzieren. Measurement without battery, with variable external power supply, starting with 1.55 V, lower tension until movement stops.
	10 μA	≤ 1,10 μA	Consommation du mouvement. Stromaufnahme Uhrwerk. Consumption of movement.	Mesure sans pile, avec alimentation extérieure de 1,55 V. Messung ohne Batterie, mit Speisegerät 1,55 V. Measurement without battery, with power-supply unit 1.55 V.
4	• 10 kΩ	0,90 – 1,40 kΩ	Continuité du bobinage. Zustand der Spule. Condition of coil.	
Ohmmètres avec tension de mesure supérieure à 0,40 V inappropriés, tension recommandée 0,20 V. Ohmmeter mit Prüfspannung über 0,40 V ungeeignet, empfohlene Spannung 0,20 V. Ohmmeter with a test voltage higher than 0.40 V unsuitable, recommended voltage 0.20 V.				

Les tests doivent être effectués dans une température ambiante entre 20° C et 25° C.
 Die Tests sind bei einer Umgebungstemperatur zwischen 20° C und 25° C durchzuführen.
 The tests must be conducted at an ambient temperature of between 20° C and 25° C.

Les montres ne doivent pas être stockées avec la couronne en position 2* (augmentation de la consommation !)

* Tige tirée.

Die Uhren dürfen nicht mit der Krone in Position 2* gelagert werden (erhöhter Stromverbrauch !)

* Stellwelle gezogen.

The watches must not be stocked with the crown in position 2* (the current consumption is higher !)

* Winding stem pulled out.

Nous nous réservons tous les droits sur ce document. Il est confié au destinataire. Il ne peut, sans notre autorisation écrite, être copié, reproduit, communiqué à des tiers.
 Für dieses Dokument behalten wir uns alle Rechte vor. Es ist nur für den Empfänger bestimmt. Ohne unsere schriftliche Bewilligung darf es nicht kopiert, vervielfältigt und Dritten zugänglich gemacht werden.
 We reserve all rights for this document. It is meant for the recipient only and it may not be copied, printed or given to a third person without our written permission.

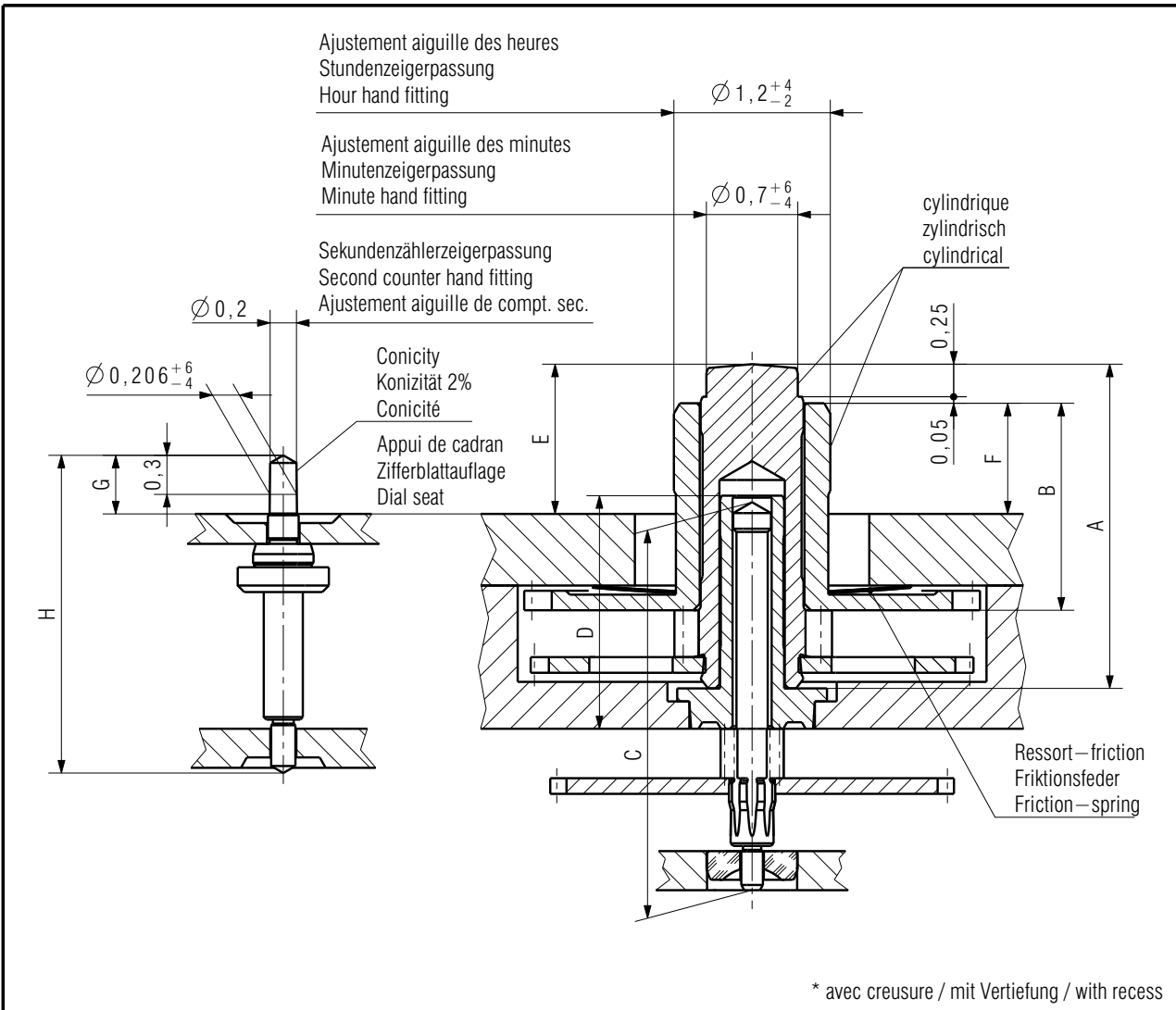

* avec creusure / mit Vertiefung / with recess

Aiguillage Zeigerwerkhöhe Hand fitting height	Longueur/Länge/Length					Dépassement Höhe über Zifferblattauflage Height over dial seat			Ep.cadran Zifferblattstärke Dial thickness
	A	B	C	D	H	E	F	G	
	Chaussée Minutenrohr Cannon - pinion	Roue des heures Stundenrad Hour wheel	Pig.des sec. Sekundentrieb Sec.wheel pin.	Tube de centre Zentrumrohr Centre tube	Petite sec. Kleine Sek. Small second	Chaussée Minutenrohr Cannon - pinion	Roue des heures Stundenrad Hour wheel	Petite sec. Kleine Sek. Small second	
4	2,49	1,59	2,98	1,79	2,44	1,15	0,85	0,45	0,4 *
5	2,74	1,84	2,98	1,79	2,69	1,4	1,1	0,7	0,4

Aiguilles Zeiger Hands	Aiguille des heures Stundenzeiger Hour hand	Aiguille des minutes Minutenzeiger Minute hand	Aiguille de petite seconde Kleiner Sekundenzeiger Small second hand
Masse/Masse/Mass	max. mg	15	15
Balourd/Unwucht/Unbalance	max. μ Nm	0,8	0,8
Force de chassage/Setzkraft/Press - in force	max. N	30	30

Kaliber / Calibre / Caliber 902.501	Massstab Echelle Scale ---		CATIA V5 Masse in mm Dimensions en mm Dimensions in mm Tol.1/1000 mm
---	-------------------------------------	--	---

AIGUILLAGES ZEIGERWERKHÖHEN HAND FITTING HEIGHTS	Z0091706	Version 01	Revision 00	Blatt Feuille Sheet 01/01
---	-----------------	----------------------	-----------------------	---

ETA SA MANUFACTURE HORLOGÈRE SUISSE DEPUIS 1793 A COMPANY OF THE SWATCH GROUP	Ersatz für/En remplacement de/Remplacement for Aenderung/Modification 21601	Klass. Class. ZVACC	KUN	
	Erstellt Etabri Created 09.10.2006 NOR	Geprüft Contrôlé Controlled 23.10.2006 NOR	Freigegeben Libéré Released 24.10.2006 VET	

Cette page est laissée vide
intentionnellement en cas d'impression
au format A3.

Diese Seite wird absichtlich leer
gelassen für den Fall, dass im
A3-Format gedruckt wird.

This page has deliberately been
left blank in case of A3 format
printing.

Cette page est laissée vide
intentionnellement en cas d'impression
au format A3.

Diese Seite wird absichtlich leer
gelassen für den Fall, dass im
A3-Format gedruckt wird.

This page has deliberately been
left blank in case of A3 format
printing.

Cette page est laissée vide
intentionnellement en cas d'impression
au format A3.

Diese Seite wird absichtlich leer
gelassen für den Fall, dass im
A3-Format gedruckt wird.

This page has deliberately been
left blank in case of A3 format
printing.

**Modifications comparées aux versions
précédentes du document****Änderungen gegenüber vorher-
gehenden Dokumentversionen****Modifications compared with previous
document versions**

Version	Date Datum Date	Modification	Änderung	Modification	Page Seite Page
05	05.11.2013	Nouvelle adresse	Neue Adresse	New address	1, 4, 16
		Ajout variantes	Varianten ergänzt	Addition variants	3, 5-9
		Retrait information incorrecte (point 3)	Entfernung fehlerhafter Informationen (Punkt 3)	Incorrect information retrieval (point 3)	10
		Correction position couronne	Korrektur der Krone Position	Correction of the position of the crown	11
04	16.06.2011	Ajouter texte	Ergänzung Text	Addition text	11
03	06.07.2009	Correction du nombre de rubis	Anzahl Rubine Korrektur	Correction of number of jewels	1
02	19.05.2009	Couple minimum pour dévisser	Minimales Drehmoment zum Lösen	Minimum torque for loosening	4-5
		Nouveau plan	Neue Zeichnung	New drawing	7
		Répartition des calibres	Aufteilung pro Kaliber	Allocation per caliber	1-8
01	17.05.2000	Nouveau layout	Neues Layout	New layout	1-8
		Version de base	Basis Version	Basic version	--

Sous réserve de toutes modifications.

Änderungen vorbehalten.

All modifications reserved.

**Ce document se trouve sur le
Support Center Portal (SCP) :****www.eta.ch**

- Support Center
- Support Center Portal
- Documents techniques

**Dieses Dokument finden Sie im
Support Center Portal (SCP):****www.eta.ch**

- Support Center
- Support Center Portal
- Technische Dokumente

**This document can be found on the
Support Center Portal (SCP):****www.eta.ch**

- Support Center
- Support Center Portal
- Technical Documents



ETA^{SA}
MANUFACTURE HORLOGÈRE SUISSE
DEPUIS 1793

SC PRODUCT COMMUNICATION

Bahnhofstrasse 9
2540 Grenchen
Switzerland

Phone +41 (0)32 655 71 11
Fax +41 (0)32 655 71 74

contact@eta.ch
www.eta.ch